

MYRRHA

“Science Towards Sustainability”

Hamid Aït Abderrahim

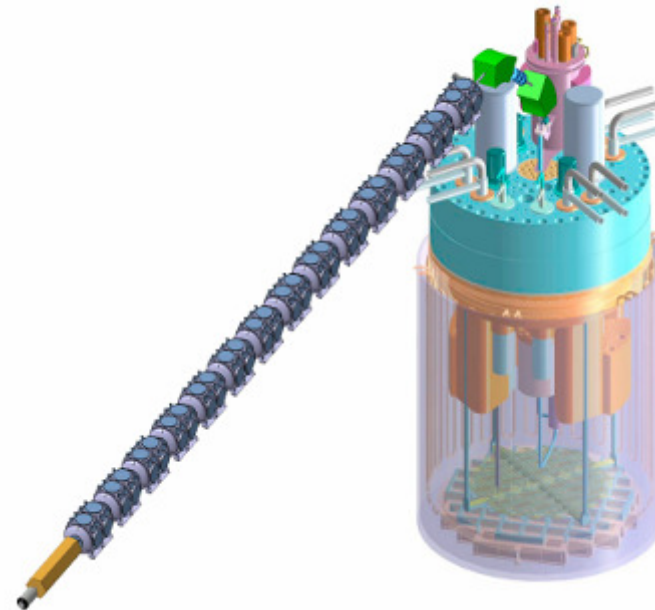

**a pan-European Research Infrastructure
Perspective of Implementation in Europe**

myrrha@sckcen.be

The Missions of MYRRHA



**Competitive
Economy**



**Energy
Independence**



**Sustainable
Society**

MYRRHA meets Belgian & European goals

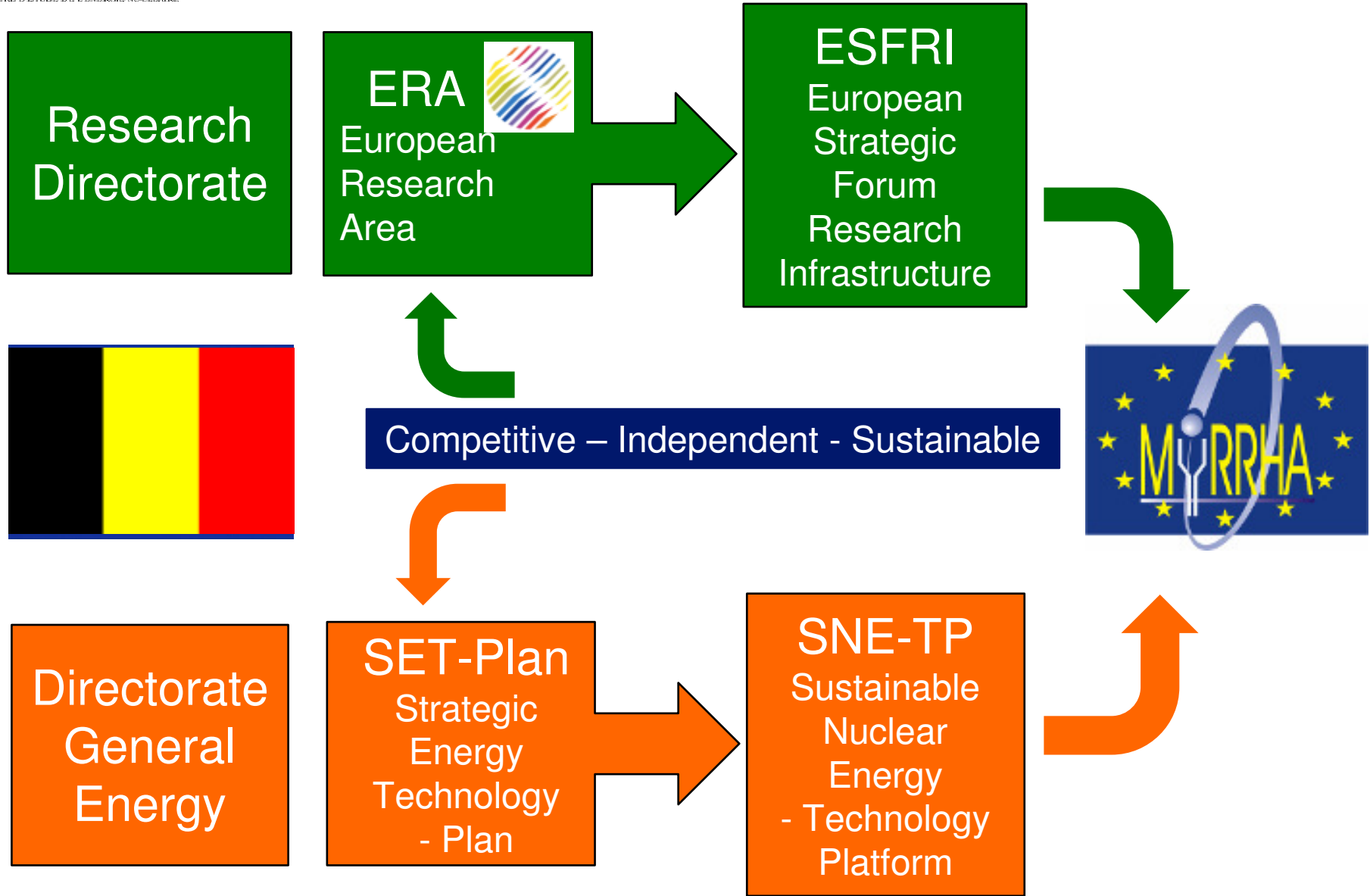

“STS” model

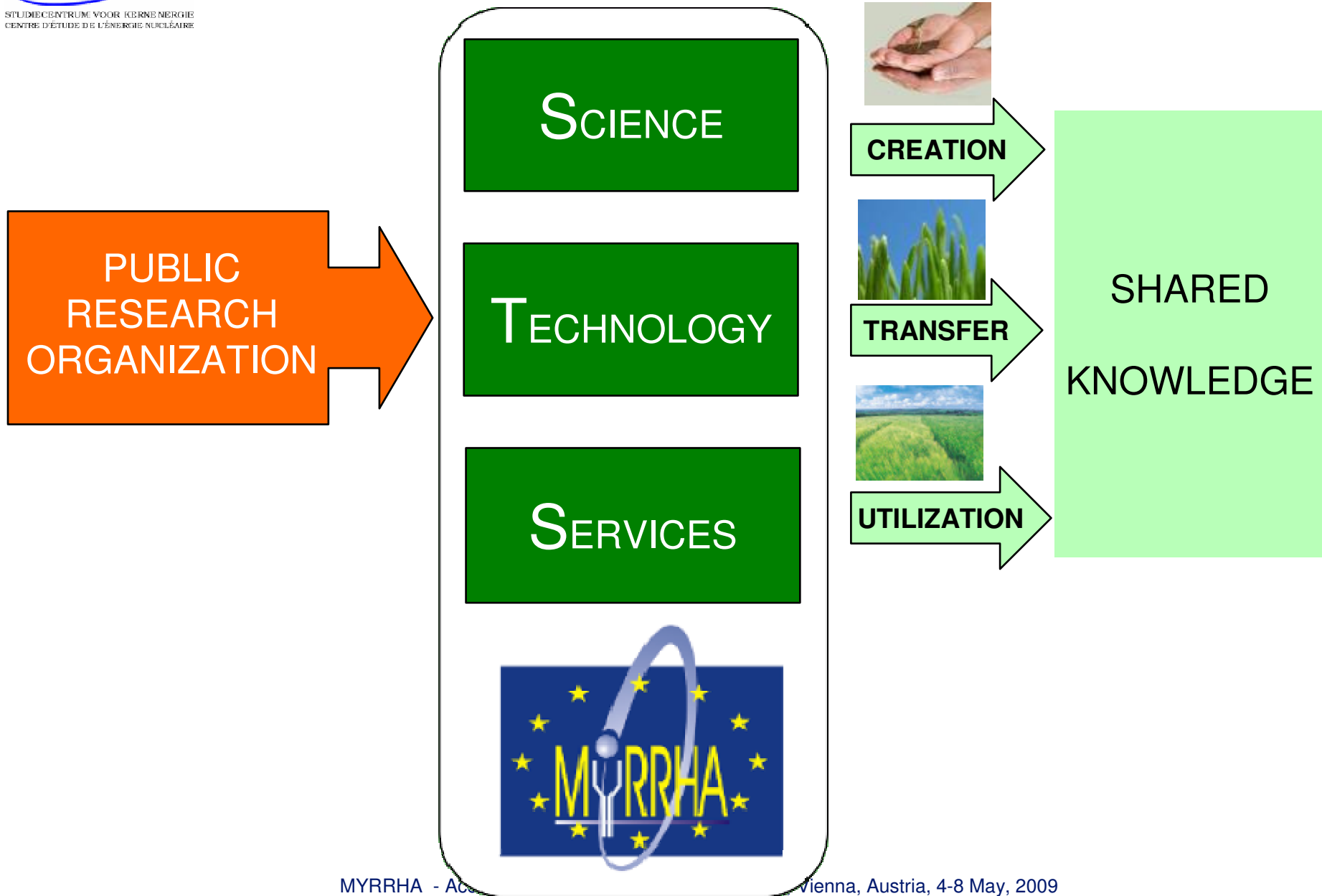

Europe is pushing cluster development as the way to economical development



Several regional clusters in Europe are strong sources of High-Tech economical activity (cf. INNOVA)

Clusters are expanding around themselves and collaborate together to form networks of clusters

MYRRHA enhances SCK•CEN European Networking

USA



Japan

MYRRHA: a European project, realised together with European centres of expertise and European industrial partners

, Vienna, Austria, 4-8 May, 2009

A legacy of “first of a kind projects”

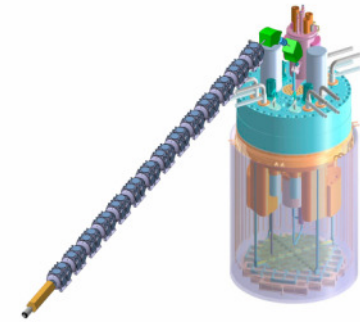
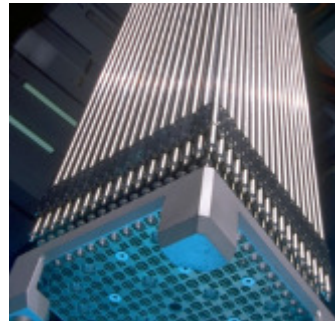
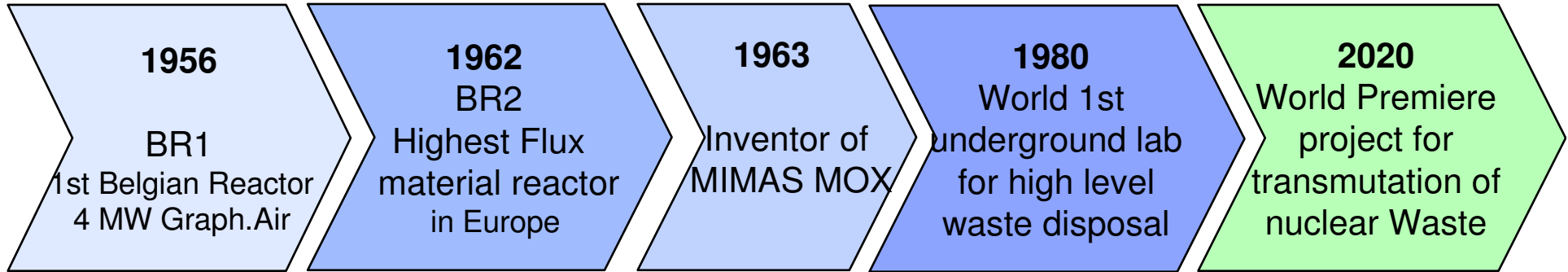

MYRRHA



BR2



A successor to BR2

1962
BR2 - Highest Flux material reactor in Europe

2020
World Premiere project for transmutation of nuclear Waste

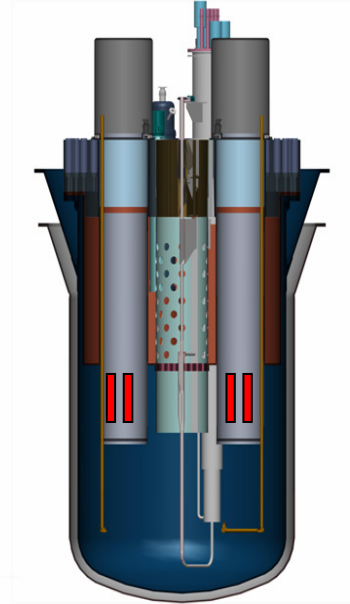
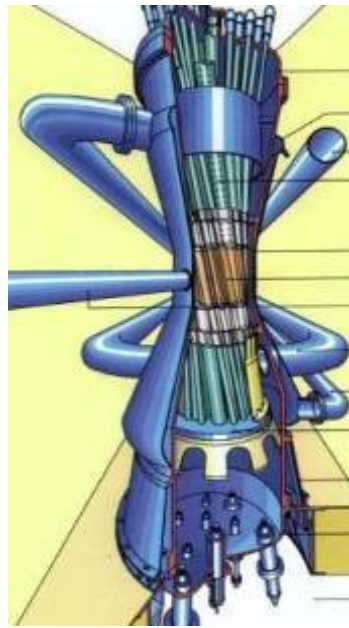
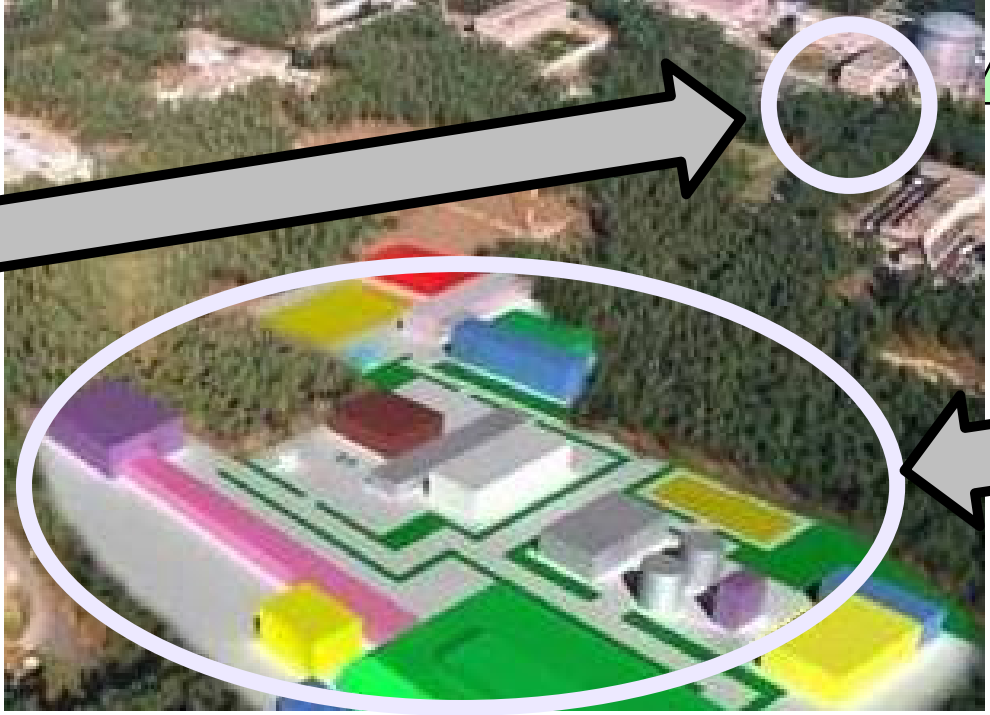

MYRRHA – a fast spectrum testing facility

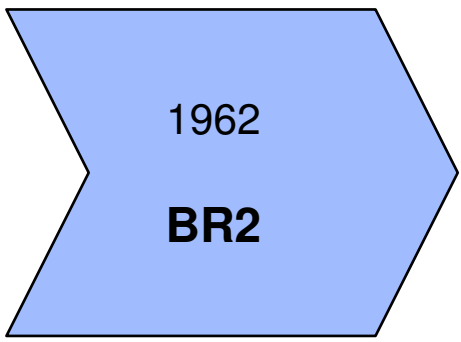
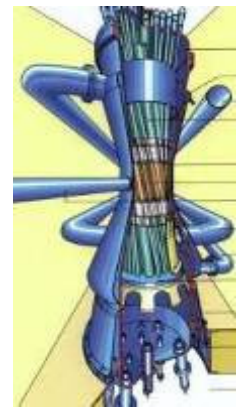

Fast Neutron
Material
Testing Reactor
(fission)

Fuel testing
For LWR
& GEN II/GEN
III

Irradiation
Services:
- Medical RI
- Silicium doping
- Others

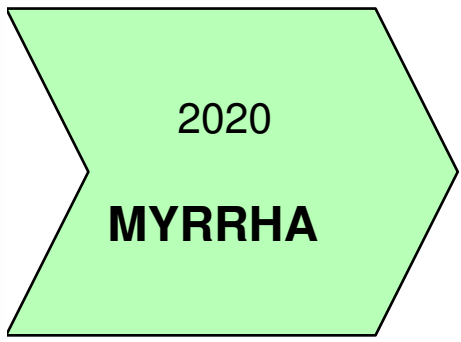
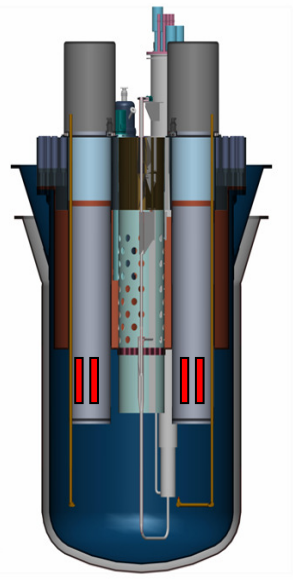
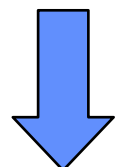
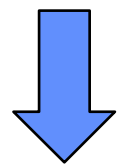
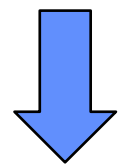

Very Fast Neutron
Material
Testing Reactor
(fission + fusion)

ADS-Demo
+
P&T testing
(Partitioning &
Transmutation)

Fuel testing
For GEN IV

Irradiation
Services:
- Medical RI
- Silicium doping
- Others

LFR GEN IV Technology demonstration

The MYRRHA concept

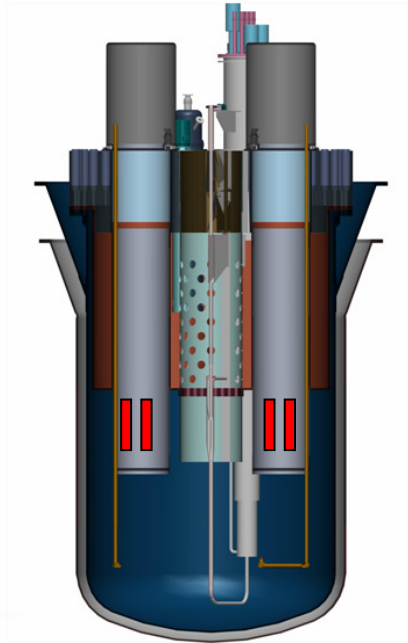

Movie A

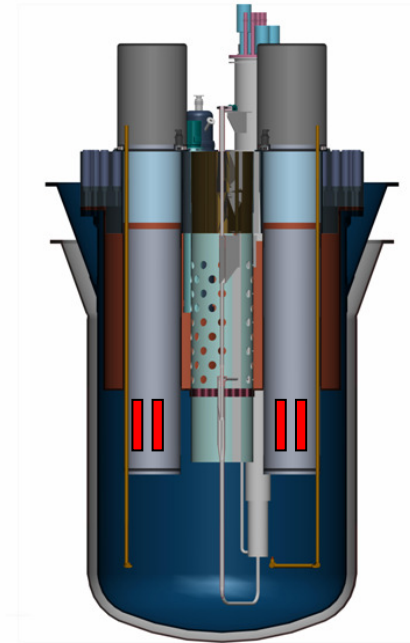

Movie B

Flexible experimental facility

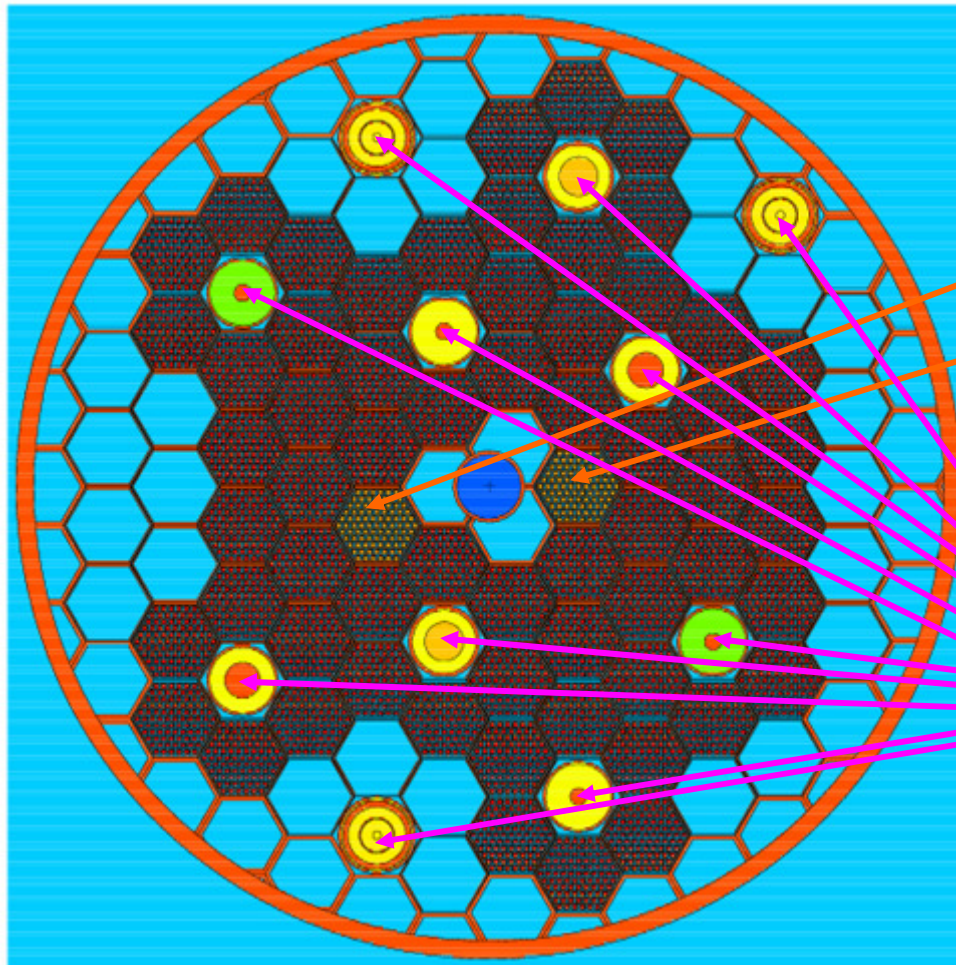

Minor Actinides
test assemblies

Experimental rigs:
• dedicated contents
• dedicated irradiation

In vessel remote handling

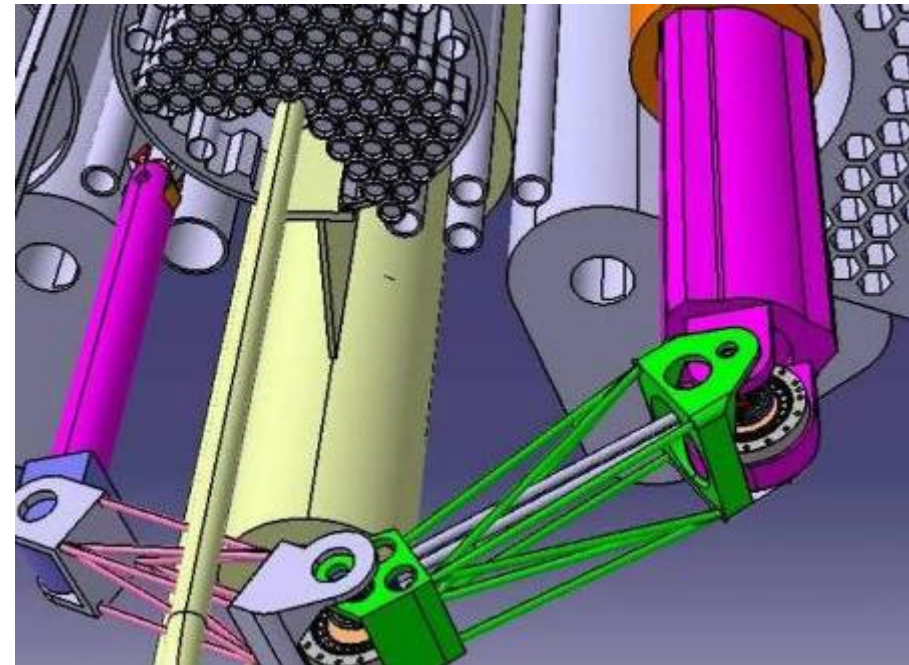
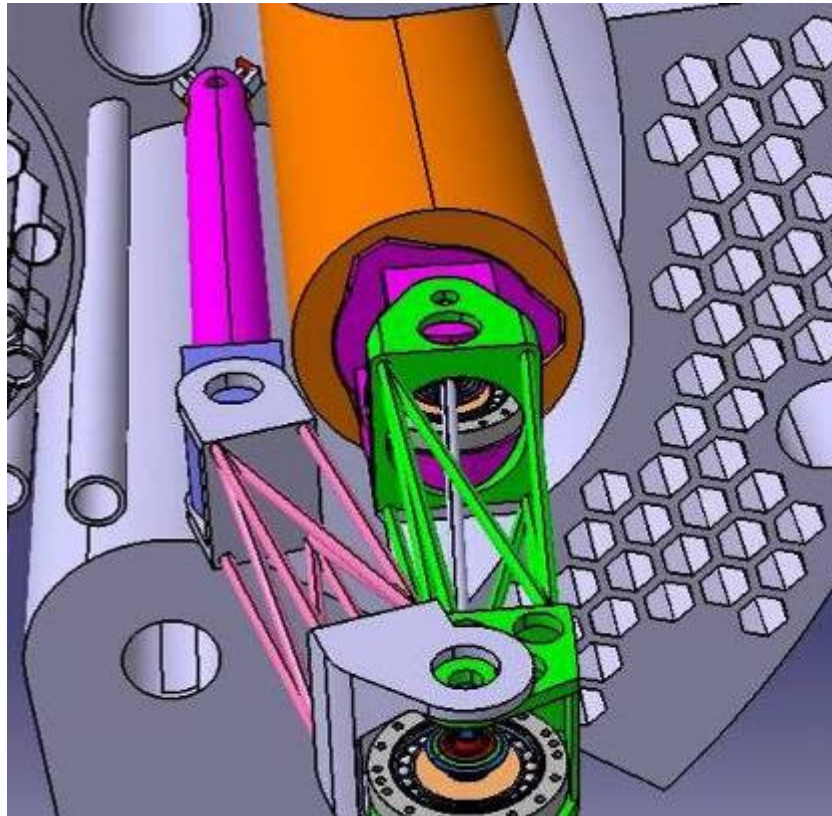

Ultrasonic imaging in PbBi @ 300° C



Mockup

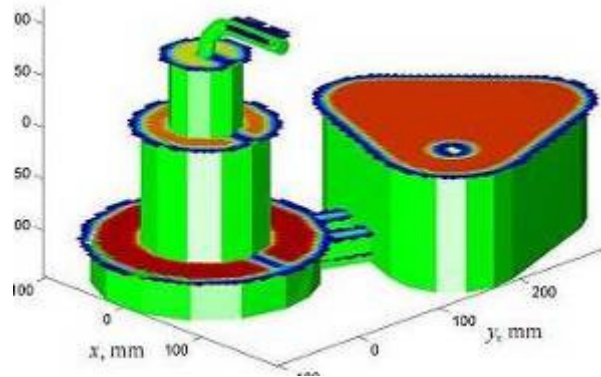

Simulated

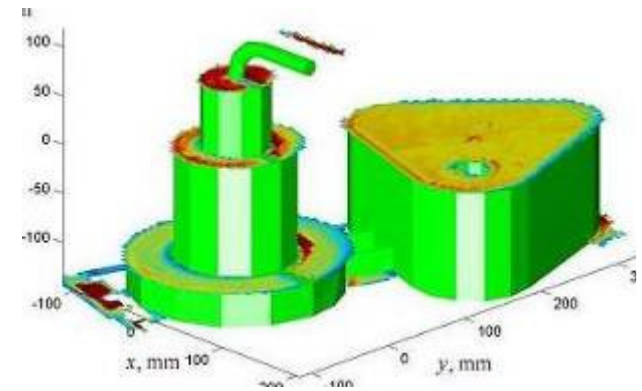

Measured

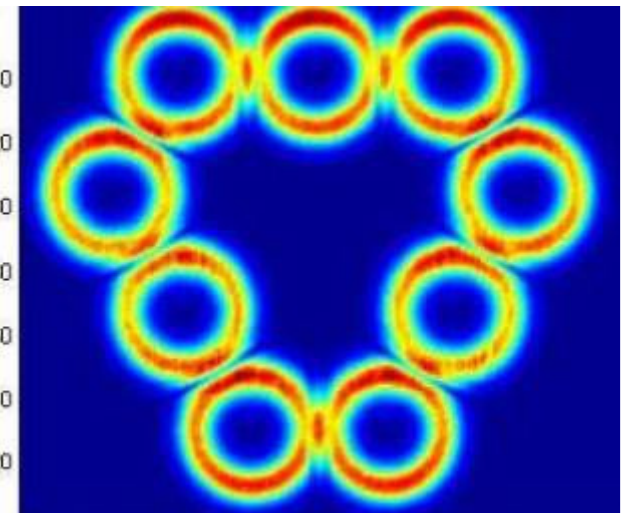
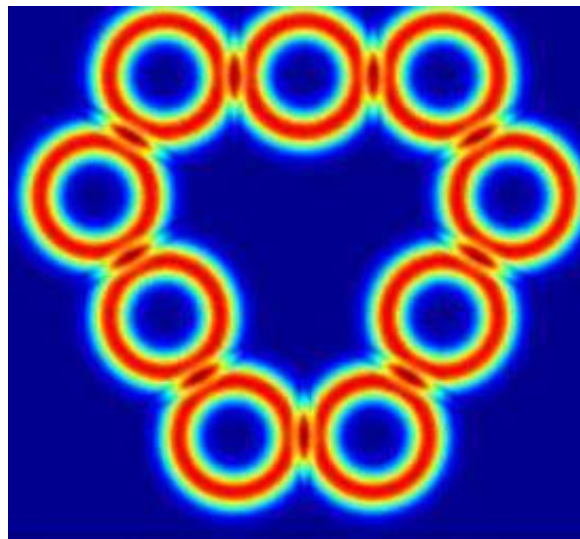
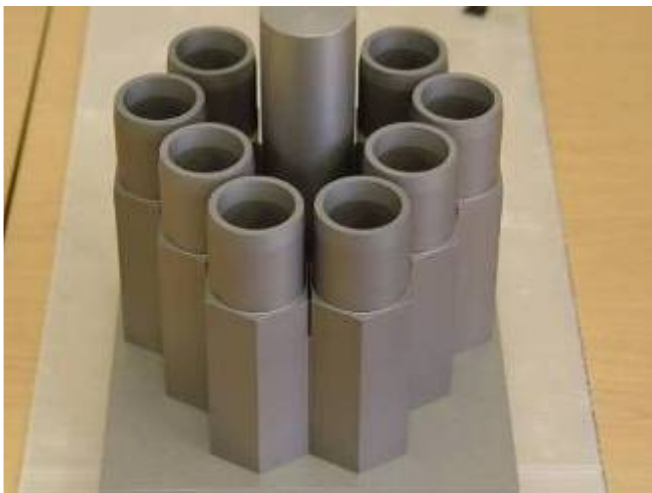

Radio-isotopes production

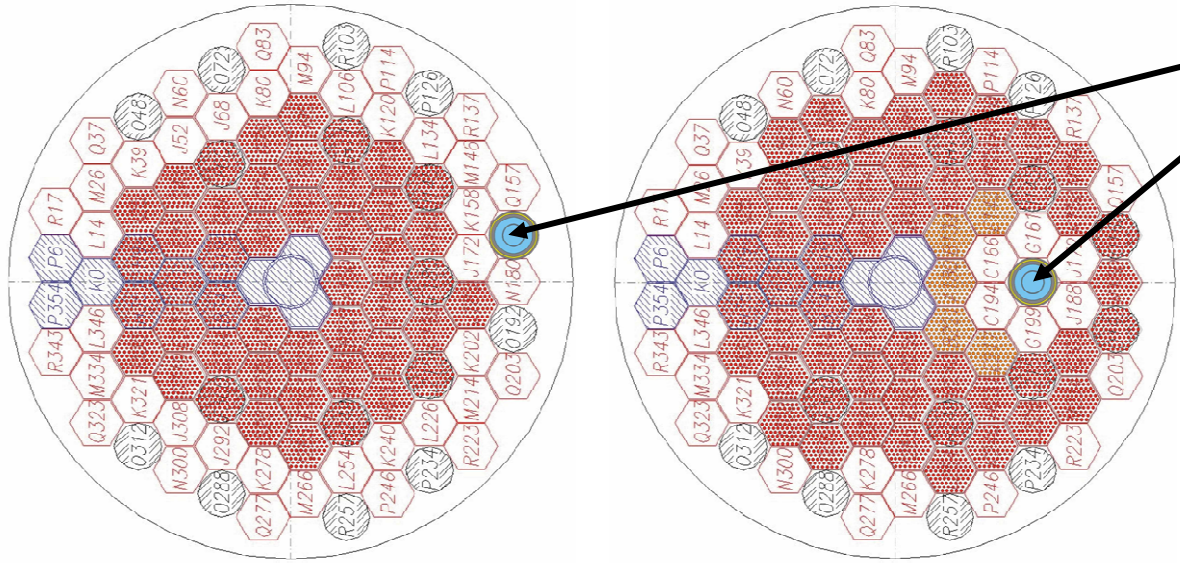

Radio-isotopes production

Ir^{nat} capsule \rightarrow ^{192}Ir

^{235}U -plates \rightarrow ^{99}Mo

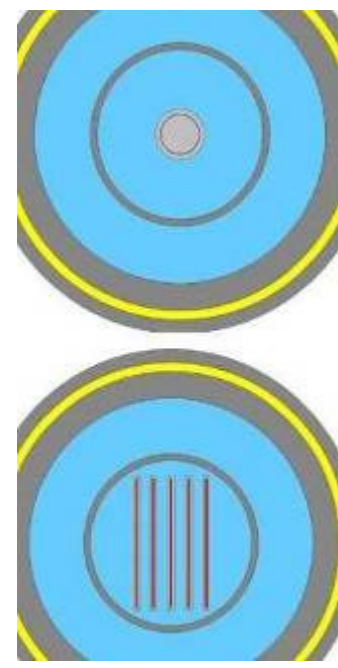

Project schedule

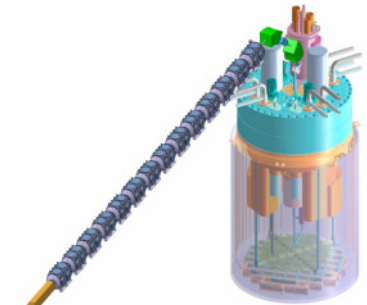
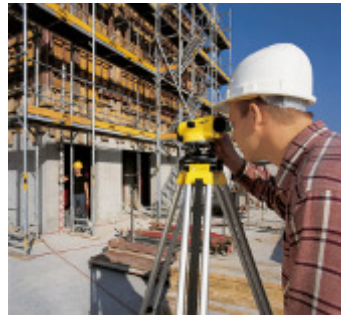
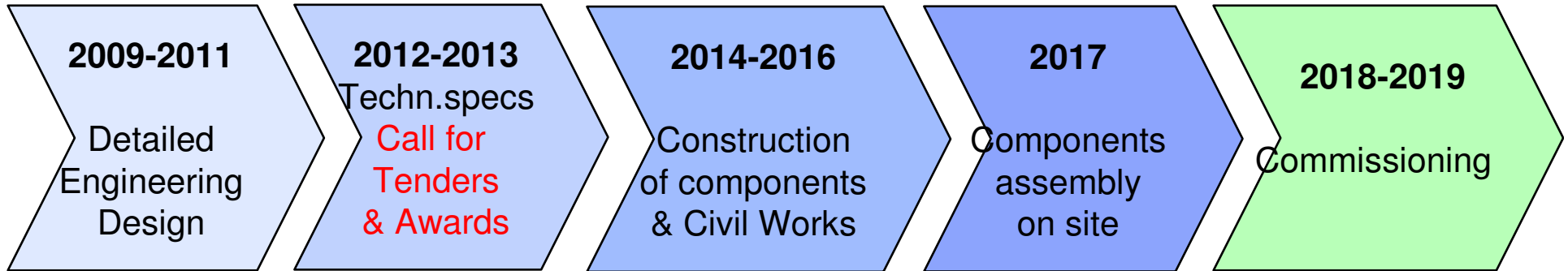

MYRRHA: Investment budget (in €2009)

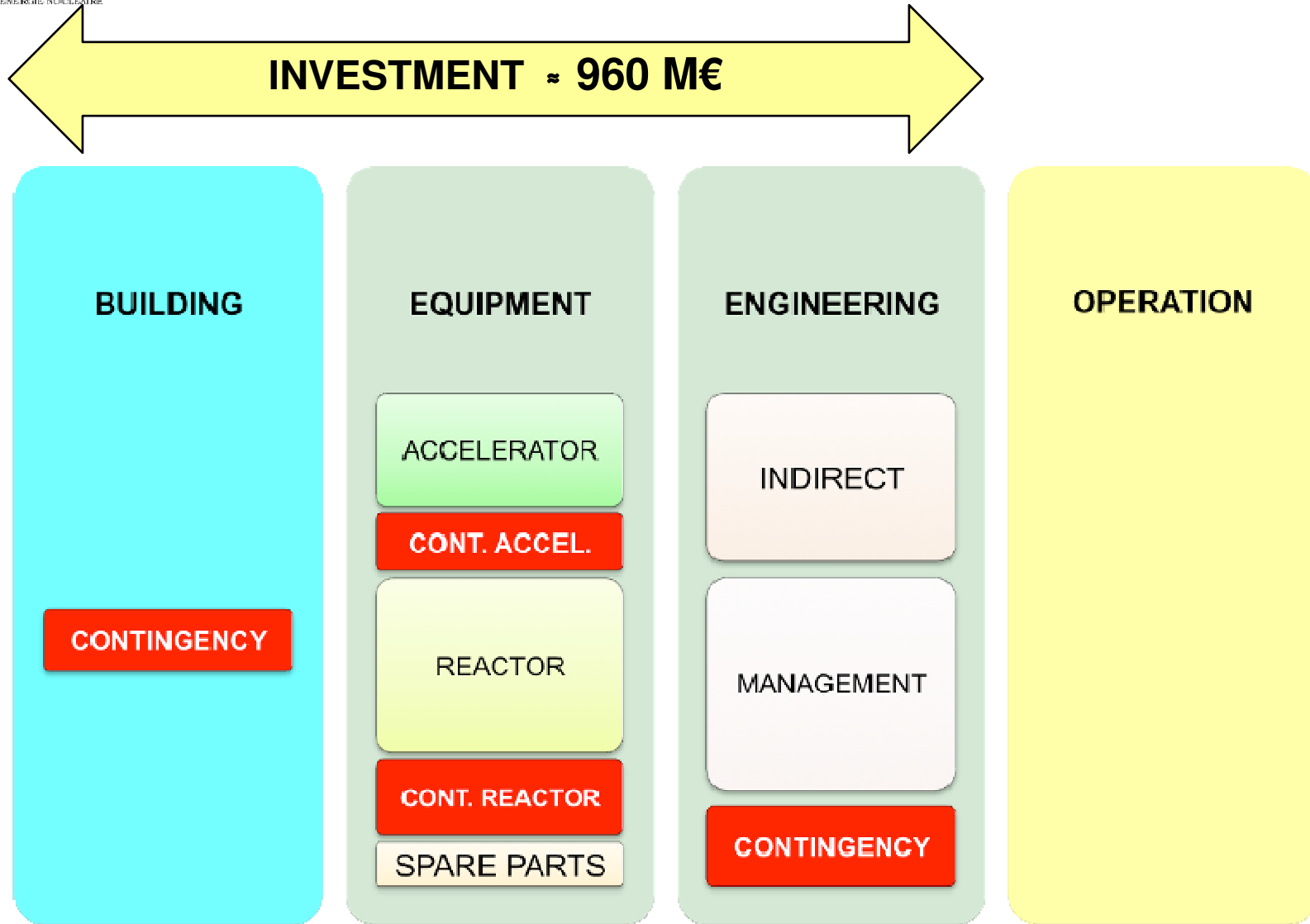

Investment blocks (proposed)

INVESTMENT ≈ 960 M€

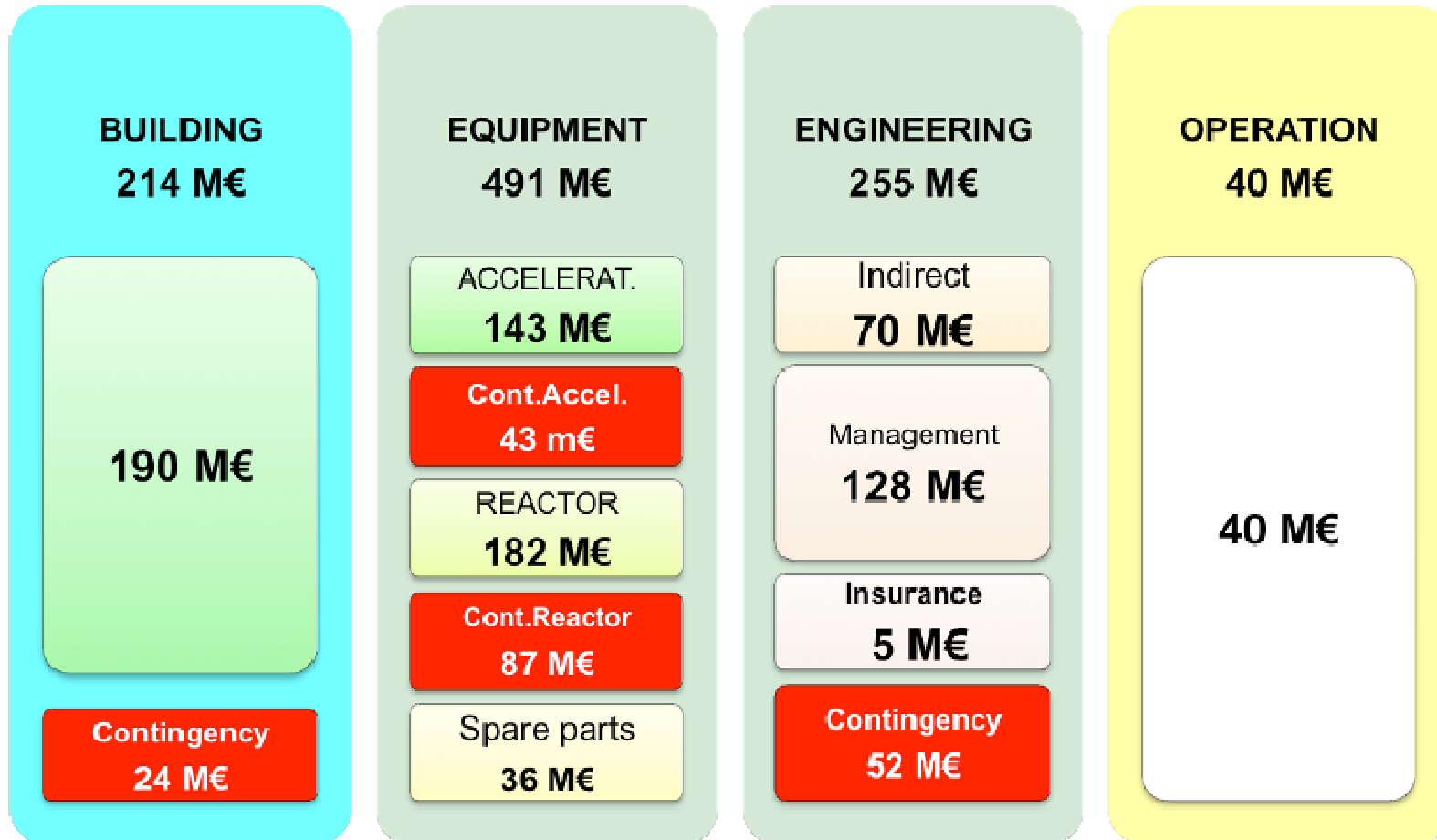

MYRRHA: Source of funds

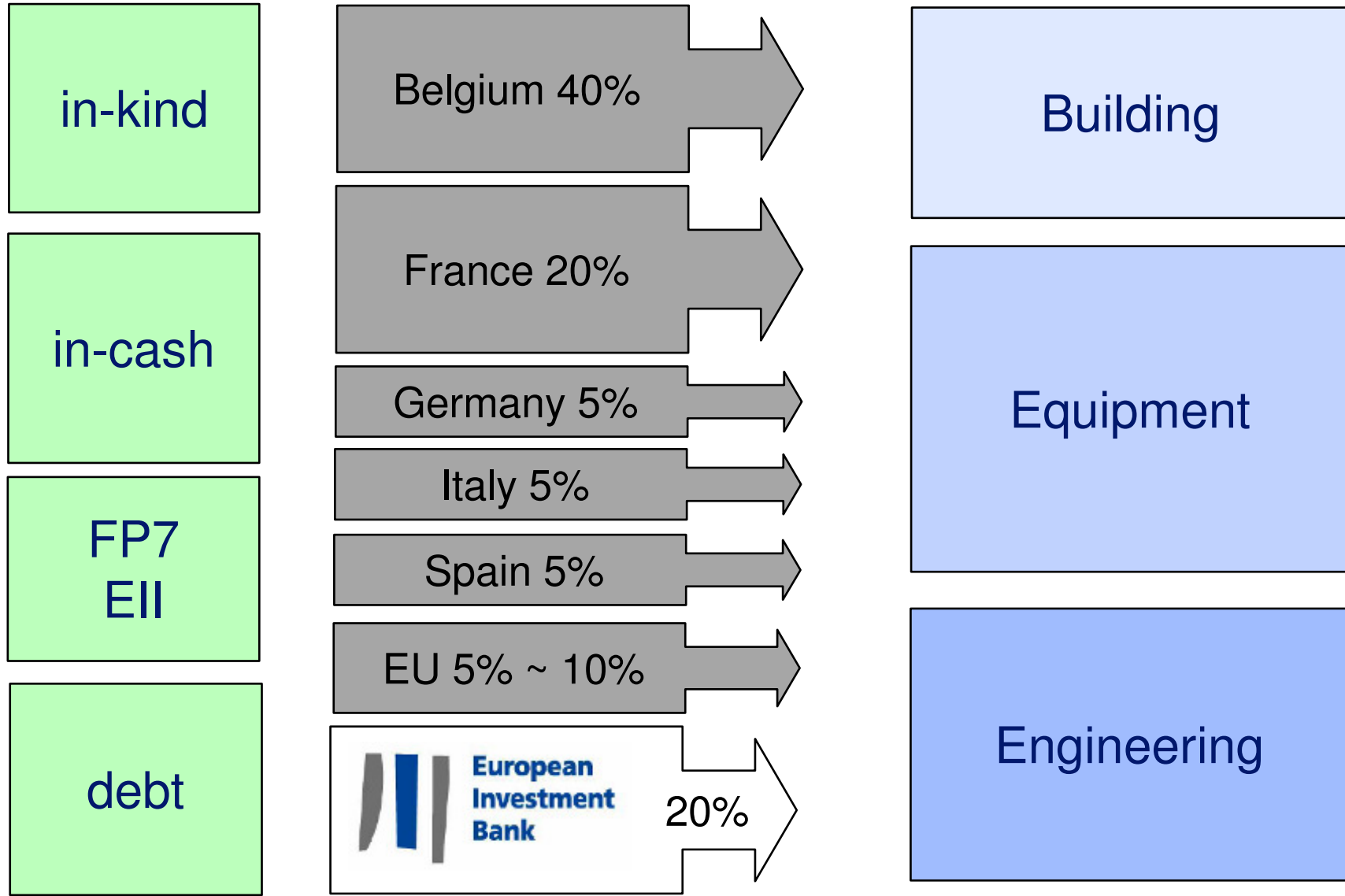

Towards a knowledge-driven economy

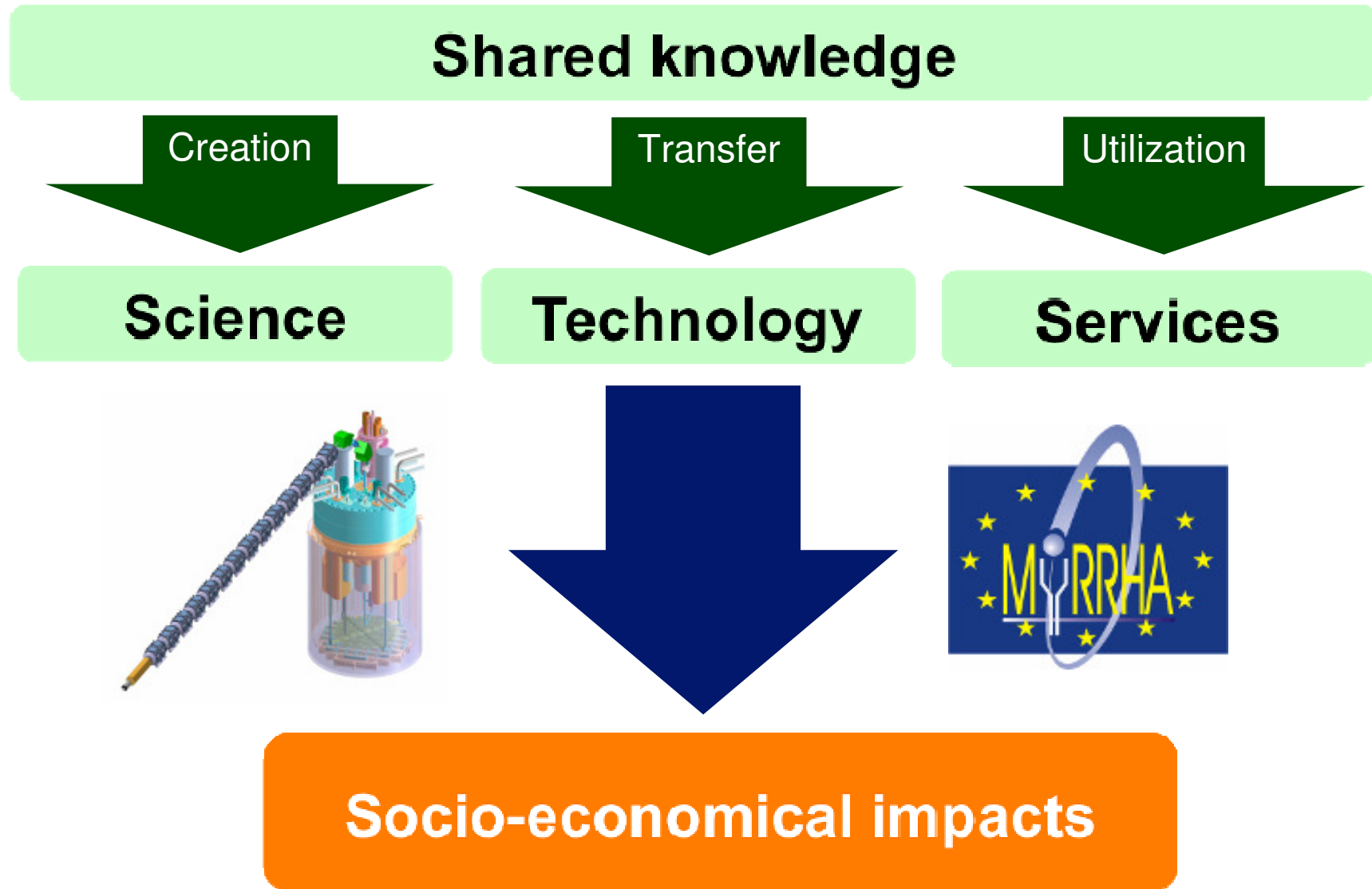

MYRRHA “STS” goals and how they fit with cluster development

Science

- Reactor physics
- Material and fuel science
- High energy particle physics
- Life sciences
- Radioprotection

Technology

Advanced:

- energy concepts
- nuclear fuels and waste solutions (decommissioning)
- medical applications
- materials and processes
- sensors, spectroscopy, imaging systems

Services

- Irradiation services
 - Radio-Isotopes
 - NTD-Silicon
 - other industrial apps
- Proton beam use
- Training & Consultancy

When the goals of SCK.CEN and those of *de Kempen meet*

Regional Development

Regional pact: "*Kempen Duurzaam*"

Cluster mgt

- Technology Park
- High Tech Cluster
- Connection to other clusters and regio's (ELAt,...)

Advanced...

- energy concepts
- solutions for nuclear fuel and waste
- medical applications
- materials and processes
- sensors, spectroscopy, imaging systems

MYRRHA

Science towards Sustainability

Research

- R&D program management and valorisation
- Open innovation



Socio-economical impacts

Today



STUDIECENTRUM VOOR KERNENERGIE
CENTRE D'ÉTUDE DE L'ÉNERGIE NUCLÉAIRE

Direct jobs
600 FTE

Indirect jobs
900 FTE

**Nuclear
Expertise**



Tomorrow



STUDIECENTRUM VOOR KERNENERGIE
CENTRE D'ÉTUDE DE L'ÉNERGIE NUCLÉAIRE

+



Direct jobs
810 SCK·CEN
150 Visiting
300 Ind. Clus.
Tot. 1260

Indirect jobs
810
150
600
Tot. 1560

**Sustainable
Nuclear
Expertise**

Economic value
•Clusters
•Spin-offs

Join the project !



Science
Technology
Services

Science
Towards
Sustainability

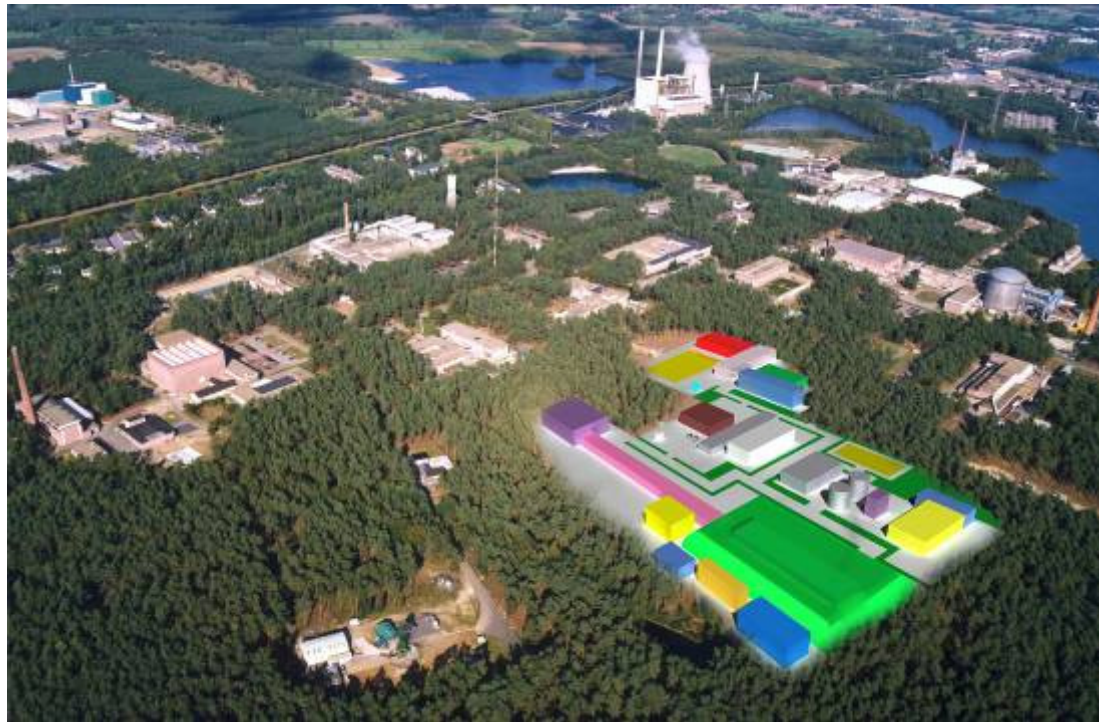

Science Towards Sustainability
Will allow the implementation of such RI